

alphatronics

Big in details

THE NEXT INNOVATION



alphatronics

smartTV



2020 CATALOGUE

Mobile Entertainment for Motorhomes and Caravans



alphatronics SMART TVs – enjoy the Internet on the road!

20 Years **alphatronics**

Big in details

We have been developing and manufacturing mobile TVs for use in motorhomes and caravans at our site in Nuremberg for 20 years now. In this, our anniversary year, we present the technology for the mobile TVs of the future.

As of this year, all our TVs will offer the advantages of mobile Internet. And that's not all: we are also introducing two completely new product lines. Let's start with our new premier line. The new S-Line is pushing the boundaries of what is technologically possible. Our developers have created a completely new concept for mobile TV. The highlight is the division of the TV into two separate parts, the display screen and the control unit. This offers many advantages in a motorhome. See for yourself.

Our new SLA-Line+ offers a unique set-up. Thanks to the new alphatronics SMART TV feature (Android operating system) you can conveniently surf the Internet or select any app from the app store. And the best thing: the powerful sound that emanates from the integrated soundbar. The loudspeakers project sound towards the front: ideal for the special usage conditions in motorhomes. And our developers in Nuremberg didn't stop there! The models in the SLA-Line+ are the first mobile TVs with Bluetooth aptX low latency technology. This enables CD sound quality via Bluetooth transmission. Furthermore, low latency transmission from the TV to headphones ensures that the image and sound are perfectly synchronised. You have the choice of a 22", 24" or 32" TV screen.

The superior quality, tried-and-tested SL-Line+ will be hooked up to the Internet this year thanks to alphatronics' Basic Smart feature (Linux

operating system). As well as having access to an Internet browser, you will also now be able to mirror your smartphone's screen content on your TV (as you can with all alphatronics TVs) using the DLNA/Miracast feature. Further new features include the new triple tuner (DVB-S2, DVB-T2 HD, DVB-C, with CI+), Bluetooth 4.2 (for sending and receiving music) and the integrated DVD player. Screen sizes of 19", 22", 24" and 32" offer a wide variety of models.

The new T-Line+ in silver will also be equipped with the Basic Smart feature this year. The T-Line+ models do not include a DVD player, scoring points instead for their compact size and comprehensive features. As with all alphatronics TVs, the compact, practical AN 5 DVB-T antenna is included in delivery.

We hope you enjoy discovering the countless advantages of alphatronics TVs on the following pages. And finally, we would like to thank all of our employees, customers and partners. Without all of you, the alphatronics success story would not have been possible. We are united by our passion for the motorhome lifestyle.

Warmest regards from Nuremberg

Jens Kaltenbach

Markus Schröder

34



alpatronics | S-Line+

Masterpiece of Technology.
Innovation that makes sense.

36



alpatronics | SLA-Line+

Unique sound quality.
Unlimited SMART-TV functionality.

42



alpatronics | SL-Line+ Individual

Mobile Internet made easy.
A new definition of mobile TV.

50



alpatronics | T-Line+

Elegant colour, slim design.
Slimline model in widescreen format
for maximum cinematic effect.

55



alpatronicsSound | Bluetooth sound system

Great sound – wirelessly!
The innovative Bluetooth sound system from alpatronics.

56



Alpine navigation systems

Enjoy a superior sound experience,
arrive relaxed!
High-end navigation systems

60



Alpatronics | DVB-T antennas

For the best reception
wherever you are.
VB-T antennas from alpatronics



Did you know? alpatronics has been awarded the “Innovativ durch Forschung” (Innovation through Research”) seal of approval.

Award-winning alphatronics

12 TVs in extensive comparison test





Winners of the Reisemobil International award

In an extensive comparison test carried out by the Reisemobil International trade magazine, alphasonics' SL-Line+ was crowned the winner. From the twelve brands included in the comparison, the SL-Line+ stood head and shoulders above its competitors.

Experts tested TVs in the categories of image quality, sound quality, on/off switch, pixel error class, Bluetooth and USB recording.

The only alphasonics TV in the test scored points thanks to its integrated Bluetooth module and choice of features.

Visit www.alphasonics.de to see the test report in its entirety.



Reliable quality you can trust.

All alphanonics TVs are manufactured at the company's site in Nuremburg.



“At alphanonics, we only have one goal - to ensure that each and every customer receives the best advice possible.”

A handwritten signature in black ink, appearing to read 'Y. Cakmak'.

Yasin Cakmak,
Head of Internal Sales



“Our TVs are precisely adapted to the needs of caravan and motorhome owners.”

A handwritten signature in black ink, appearing to read 'R. Pfister'.

Reinhold Pfister,
Head of Technology



Assembled in
GERMANY
Nuremberg

Wide-angle LED TVs from alphasatronics offer:

- Reliable quality – made in Germany
- Wide-angle LED display (alphasatronicsView)
- Shock and vibration tested
- Climate tested (cold, heat)
- Screen sizes from 47 cm to 102 cm
- Integrated surge protection
- Impressive image and sound quality
- High quality stereo speakers
- 100% pixel error free panels (pixel error class 0)
- Lightweight (2.4 kg to 6 kg)
- 10.8 - 26 V DC supply voltage
- 100 - 240 V AC supply voltage
- Voltage stability from 10.8 V to a maximum of 26 V.
- alphasatronics triple tuner (DVB-S2 + DVB-T2 HD + DVB-C – MPEG 2/4)
- alphasatronicsSound
- Integrated Bluetooth 4.2 module
- Common Interface (CI+) for pay TV
- Shock-resistant DVD player
- USB 2.0 connection/media player
- HD-ready/Full HD
- Low consumption
- 5 V output for active DVB-T antennas
- “Real” on/off button
- 60 satellites pre-installed

Outstanding quality

Made in Germany

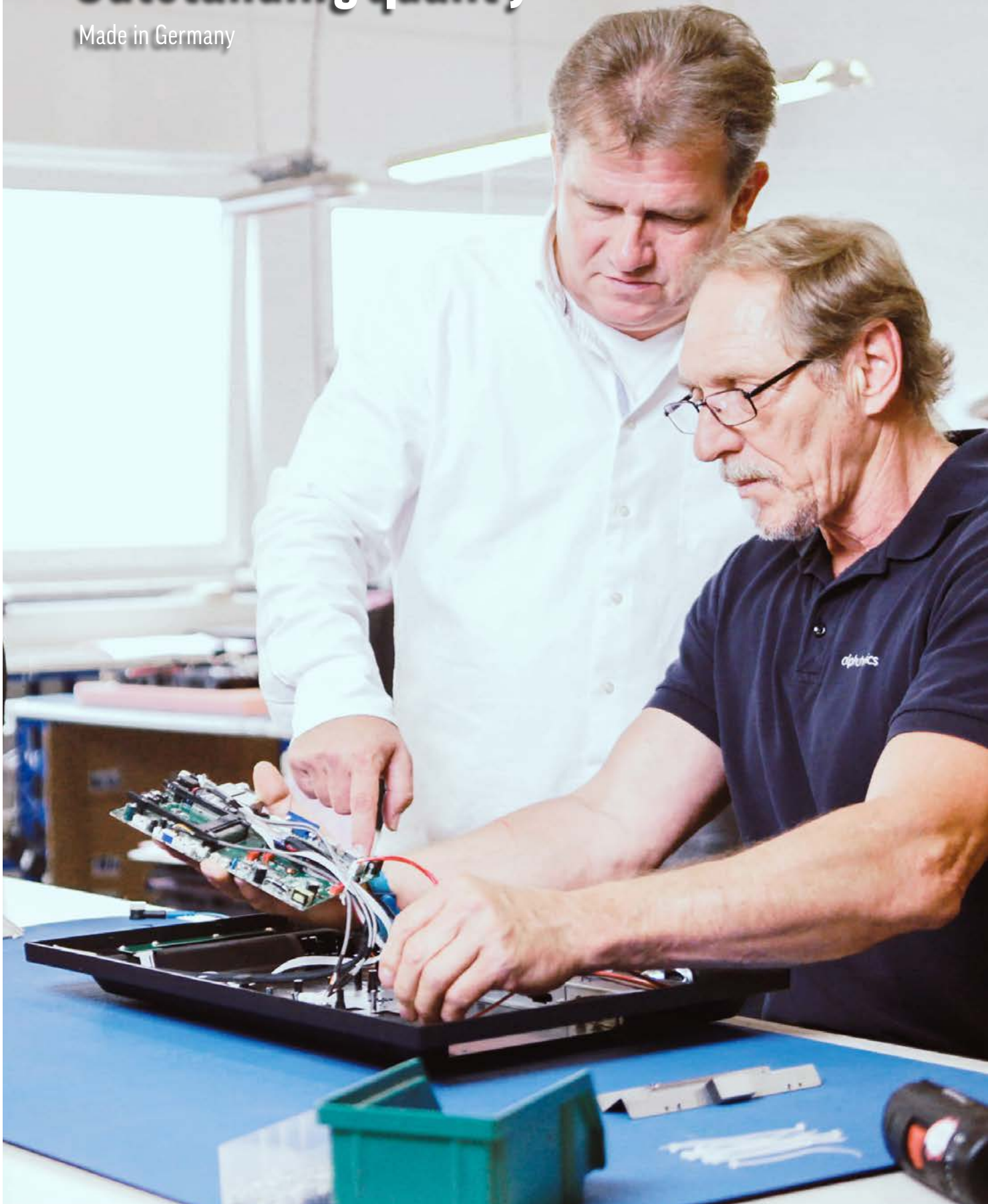



All alphanonics TVs are manufactured at our site in Nuremberg. This ensures consistently high quality so that we can meet your expectations for reliable mobile TVs.

For the last 20 years, we have been dedicated to meeting the mobile TV needs of caravan and motorhome owners. We take the experience we have gained and apply it to the development of our products. Our highly qualified staff, combined with ongoing training measures and our quality management system (DIN EN ISO 9001:2015), guarantee premium quality for our customers.

We are clearly committed to Germany as our base. All our TVs are manufactured in Nuremberg (Bavaria) by qualified employees.

From development and production to quality assurance, service and administration, all our departments have been under one roof since the company was founded. As a team, we work together every day to ensure that our products more than meet the requirements of caravan and motorhome owners. We can only achieve superior quality by working together and focusing on the tiniest details, every step of the way.

**For this reason, our philosophy is:
alphanonics – big on details.**

The world of caravanning is our home. You can also become part of the large alphanonics family. We give you our word: alphanonics TVs stand for reliable quality that you can trust.



3 years warranty on all alphanonics TVs.

We are certain: All alphanonics TVs meet the highest quality standards. For this reason, we provide a 3 year manufacturer's warranty on all alphanonics TV models (purchased on or after 1.1.2015).

4 year warranty Optional warranty extension available.

Simply visit the www.alphanonics.de website and go to the Support/Warranty Extension section to request the extended 4-year warranty quickly and easily.

**100%
pixel error free**



100% pixel error free

alphatronics LED/LCD TVs are 100% pixel error free (pixel error class 0). Other brands of TV often use either grade 1 or 2 LED panels. In such cases, up to 5 pixel errors may occur, thus impairing your viewing experience. Depending on the warranty, you would not be entitled to an exchange. At alphatronics, we assure you that we use only LED panels without pixel errors – 100% pixel error free.



alphatronics technology.

This is what perfect mobile TV looks like!



alphatronicsView – wide-angle LED display

The innovative alphatronicsView wide-angle LED display means that you can enjoy a great view of your TV from any position. Thanks to the 178-degree vertical and horizontal viewing angle, you always have the best view, no matter where you are sitting.

Using alphatronicsView technology, the wide-angle display is individually adapted to each TV model's main electronics system.

This makes the alphatronicsView wide-angle display unique in the mobile TV segment.

alpha **VIEW**

Horizontal viewing angle

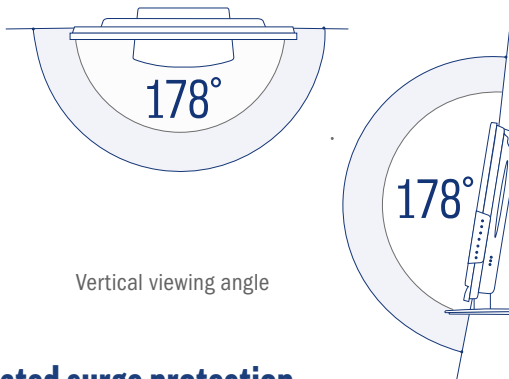

Vertical viewing angle

Integrated surge protection

All alphatronics TVs have integrated surge protection to protect against damage during short-term peak loads (engine start, solar panel start-up etc.).

alphatronics triple tuner

Three receiver units in one device – DVB-S2, DVB-T2 HD and DVB-C tuners. The CI+ slot for pay TV also comes equipped as standard.

- The benefits for you:**
- Future-proof digital triple tuner (high resolution)
 - No external receiver required
 - Only one remote control
 - Lower electricity consumption
 - TOP image quality thanks to HDTV reception
 - Integrated display of the quality level to support the alignment of semi-automatic and manual satellite systems.
 - Pre-programmed channel lists
 - Programmable channel lists
 - **10-bit colour resolution for an even greater range of radiant colours**

Shock and vibration tested



All alphatronics TVs are shock and vibration tested. In this way, we ensure a high degree of operational reliability and consistent quality for our customers.

Special climate test



In the climate test, TVs are tested under extreme conditions in a special climate chamber. This ensures that all electronic components work perfectly even in extreme heat or sub-zero temperatures (-10 degrees to +45 degrees).

alphatronicsLINK



alphatronicsLink is a control protocol further developed on the HDMI-CEC standard, which allows different terminal devices connected to the television via HDMI to be controlled easily and conveniently with just one remote control, for example the alphatronics TV remote control.

And of course, alphatronics TVs also include:

- 12 volt operation/230 volt operation
- Voltage stability from 10.8 to a maximum of 26 volts
- Integrated surge protection
- Real on/off switch
- Lower electricity consumption
- Operation and storage at extreme temperatures

The new SLA-Line+

The perfect symbiosis of unique sound quality
and perfect SMART TV features!

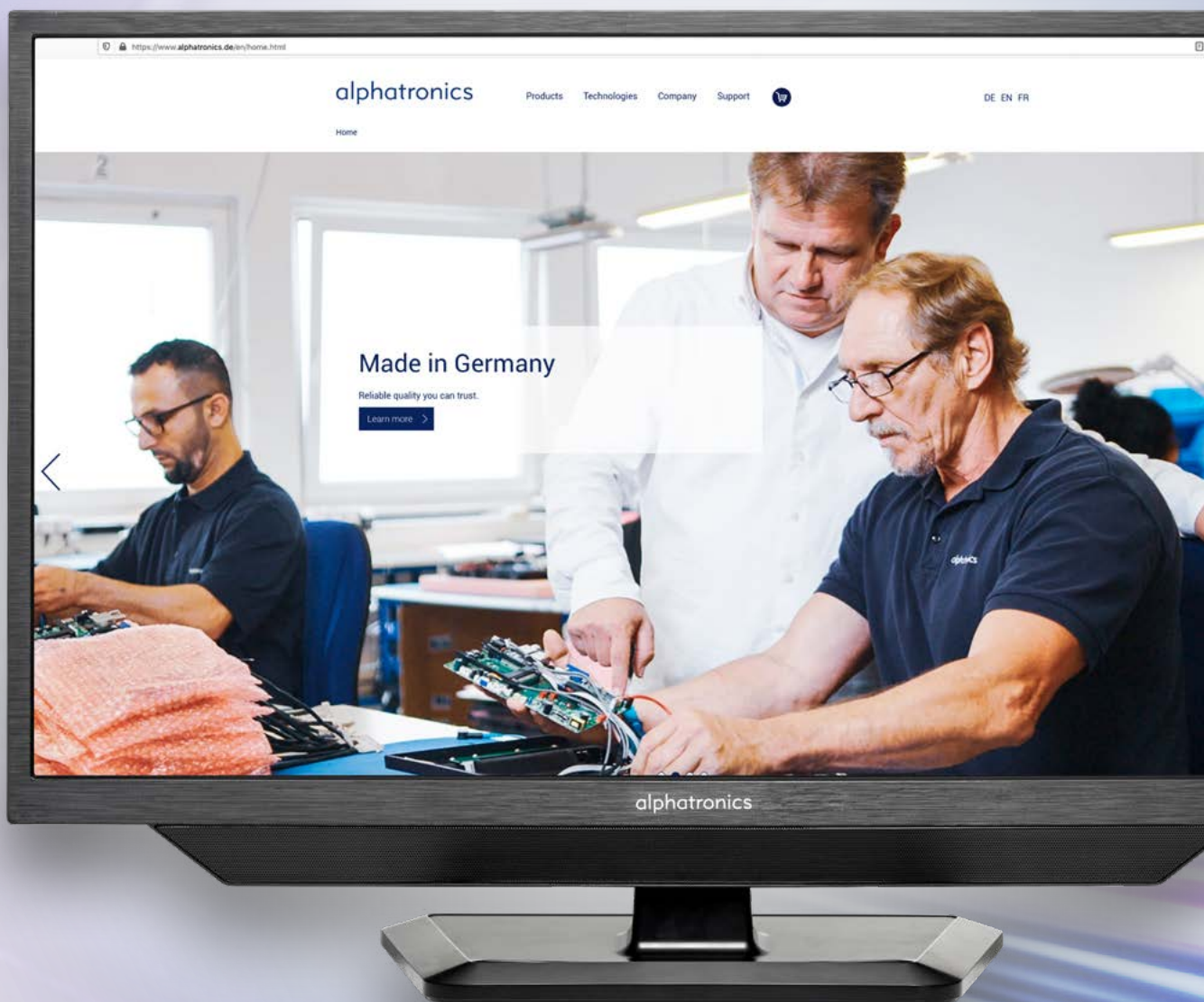



- alpatronics SLA-24 DSBAI+
- SMART TV (Android)
- 60 cm (24") screen
- Triple tuner (DVB-S2 + DVB-T2 HD + DVB-C)
- Integrated Bluetooth 4.2 module
- Bluetooth aptX low latency technology
- Miracast/DLNA feature
- DVD player



alpatronics SMART TV

Access the world of the Internet thanks to the Android system. Simply select the app you want from the app store. Surfing the Internet is easy thanks to the integrated browser.

Want to find out more about your destination, or exactly where you and your motorhome or caravan are right now? Then make the most of YouTube's variety and watch a travelogue about the local area. Or simply select any app from the app store to facilitate your caravan or motorhome journey (e.g. parking space app or petrol station finder). Use the Miracast/DLNA feature to mirror your smartphone's screen content on your TV.



AUDIO-LINE
Powerful
Sound-System



The best sound of all mobile TVs!

Working hand-in-hand with the designers of the new SLA-Line+, alpatronics' sound specialists have tailored the integrated soundbar to meet the needs of motorhome and caravan owners: the high-quality stereo loudspeakers in the housing project sound towards the front, and have been coordinated with specially developed software to reproduce highly intelligible speech and create an impressive sound experience.



Innovation from alpatronics - the first mobile TV with Bluetooth aptX low latency technology!

- Bluetooth aptX enables CD sound quality thanks to an improved compression process.
- Lower latency - ideal for audio transmission from TV to headphones
- Perfect synchronisation of image and sound

alphatronics Second Screen

Keep it simple: smart networking, intelligently done.



alphatronics SL-22 DSBI+
Integrated Basic Smart feature
55 cm (22") screen
Triple tuner (DVB-S2 + DVB-T2 HD + DVB-C)
Integrated Bluetooth 4.2 module
DVD player

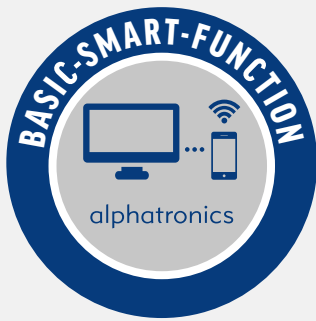

alphatronics SL-Line+ with Basic Smart feature (DSBI+)

- Surfing the Internet is easy thanks to the integrated browser
- Pre-installed apps
- Easy mirroring of smartphone/tablet screen content on your TV (Miracast/DLNA feature).

Available in the SL-Line+ - DSBI+ model.



alphatronics - once again thinking one step ahead!

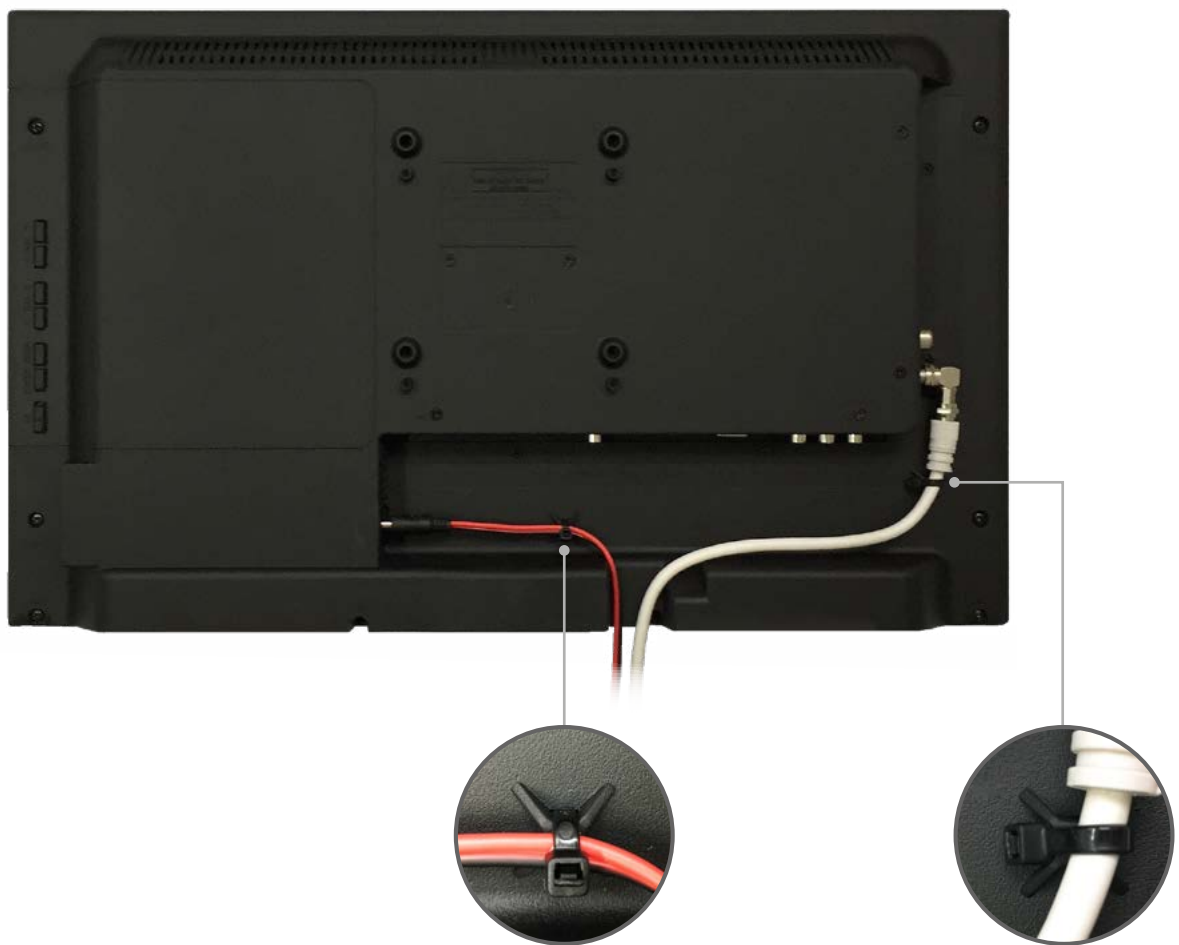

The innovative, practical cable management system makes cabling your alphatronics TV easy.

The pre-installed cable holders offer secure, non-slip fixation of the connecting cables.

Say goodbye to annoying cable spaghetti, bad contacts, and damaged connectors.

Available in all models in the SLA-Line+, SL-Line+ (not including 32" screen) and T-Line+.

We save electricity for you.



eTV

alphatronics SL-19 DSBI+
LED display
47 cm (19") screen
Electricity consumption <19W (max.)
Standby < 0.5W
On/off switch

**You don't want a TV that consumes electricity when you're not using it, do you?
alphatronics' energy-saving eTVs make this a reality.**



Save electricity and make an active contribution to the environment. alphatronics' new eTVs have a specially developed electronics system which has reduced the electricity consumption of the wide-angle LED devices by up to 50%. Thanks to the real on/off switch, the eTVs consume no power even when on standby for long periods of time. And you can also save power in radio mode by switching off the LED panel.

All alphatronics models with on/off switch.

**From now on, you can conveniently control
the satellite system with your TV remote.**



alpatronics SL-22 DSB+ K

55 cm (22") screen

Triple tuner (DVB-S2 + DVB-T2 HD + DVB-C)

Integrated Bluetooth 4.2 module

Integrated Kathrein control

DVD player

alpatronics



One-Cable-Solution

alphatronics and Kathrein One-cable solution

Together with Kathrein, alphatronics has developed the innovative “one-cable solution”. The -K variant enables you to control various fully automated Kathrein satellite systems directly via your TV without even needing an additional remote control or receiver.

Available in the SL-Line+ Individual.



alphatronics MOBILE HOME AUTOMATION

Welcome to the motorhome of the future

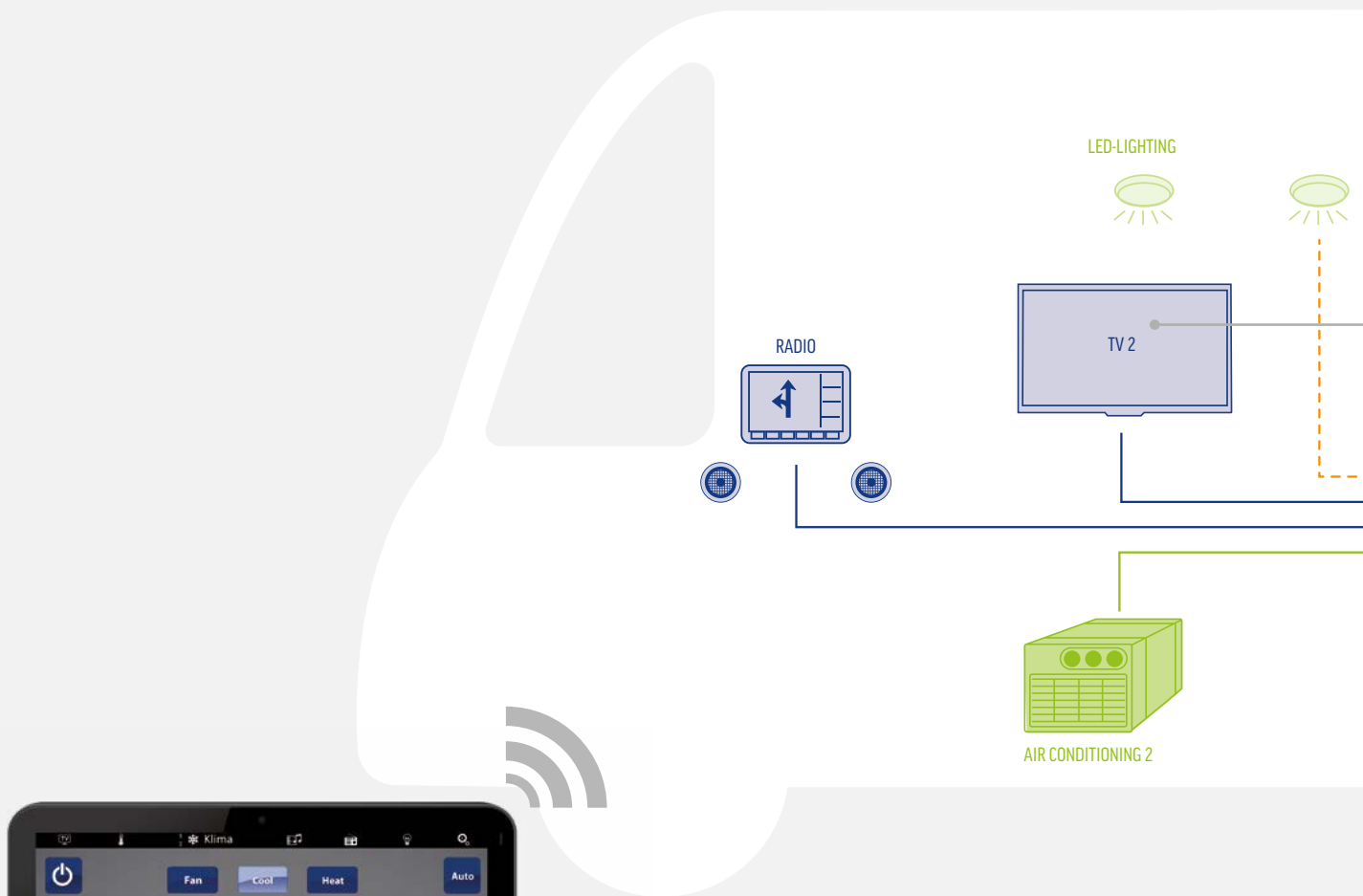

CONTROLS



ON-BOARD ELECTRONICS



MULTIMEDIA

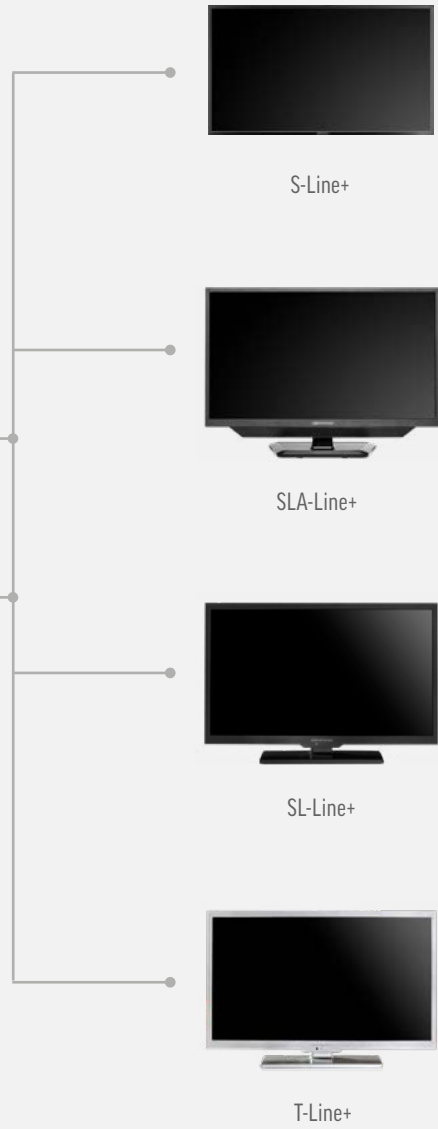
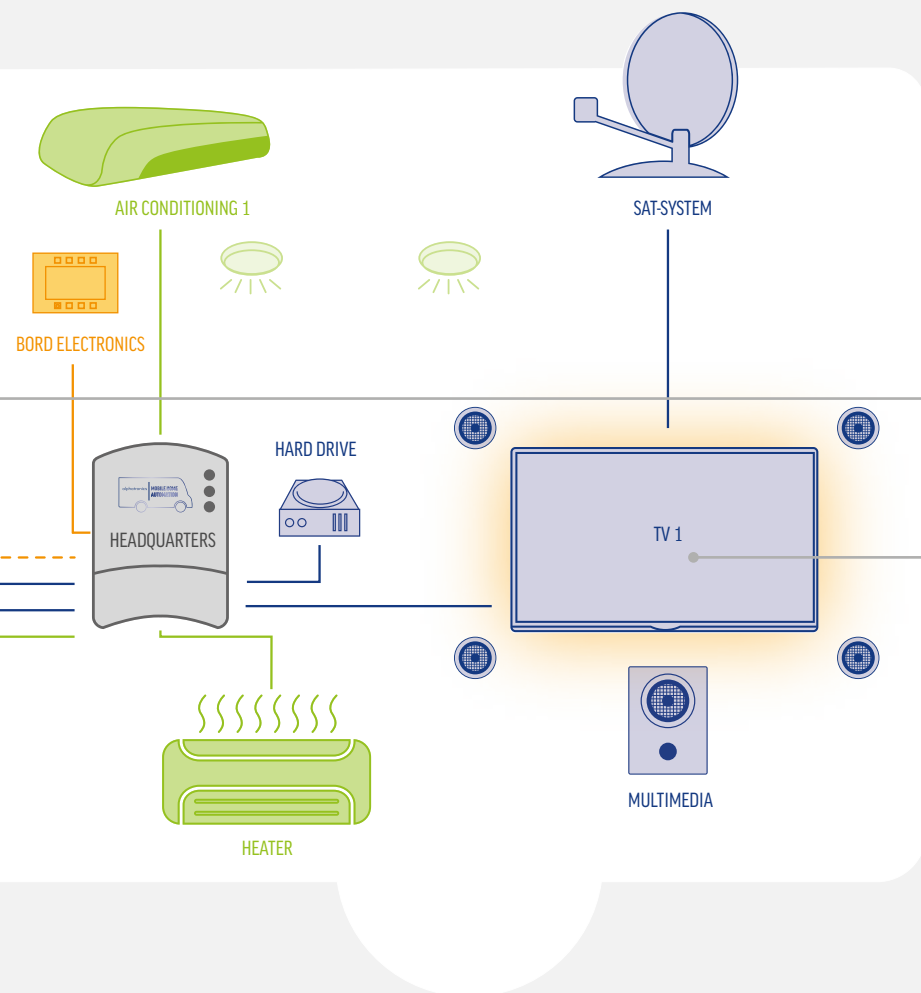

Thanks to the alpatronics MOBILE HOME AUTOMATION system, operating and controlling a wide range of components in your motorhome or caravan is child's play.

Adjust the air conditioning or the heating, dim the lights, or change channels on the TV. These are just some of the features that from now on, you can easily control with one swipe of your tablet. For improved comfort, greater efficiency and that wonderful feeling of having everything under control.

For detailed information, go to www.mobilehomeautomation.de

For flexible, wireless listening pleasure.



alphatronics SLA-22 DSBAI+

55 cm (22") screen

Triple tuner (DVB-S2 + DVB-T2 HD + DVB-C)

Integrated Bluetooth 4.2 module

Bluetooth aptX low latency technology

Smart TV (Android)

DVD player



Comprehensive range of options!

- Wireless connection of Bluetooth speakers, headphones, navigation systems, radios, mobile phones, laptops and much more.
- The perfect home cinema sound experience
- Receive satellite radio stations via your TV and use alptronicsSound speakers, for example, under the awning or in the sleeping area!
- **Simply connect your Bluetooth headphones to the TV (with the option to listen via headphones and TV speakers simultaneously).**
When using the Bluetooth headphones, the volume of the TV and the headphones can be controlled separately.

The benefits for you:

- Impressive sound experience
- Quick and easy to install
- No cable laying, easy to set up
- Bluetooth range approx. 100 m (Bluetooth 4.2)
- Low consumption (low energy)
- Any Bluetooth-enabled receiver can be connected

New for 2020 – Send and receive

Thanks to the alptronics Bluetooth 4.2 module, not only can the TV send audio signals via Bluetooth, it can also play music from a mobile phone through the TV!

Convincing (wireless) sound experience? alptronicsSound – the Bluetooth sound system

The new alptronicsSound sound system gives you an impressive sound experience in your motorhome or caravan. Connect your alptronicsSound sound system or any other Bluetooth-enabled device (navigation system, radio, etc.) wirelessly via Bluetooth. For TVs without an integrated Bluetooth feature, we offer a convenient Bluetooth upgrade module.



alptronicsSound Bluetooth 4.2 module: Integrated into all TVs.

Mobile TVs with wide-angle LED display.



alphatronics T-22 SBI+

LED display

56 cm (22") screen

Triple tuner (DVB-S2 + DVB-T2 HD + DVB-C)

Integrated Bluetooth 4.2 module

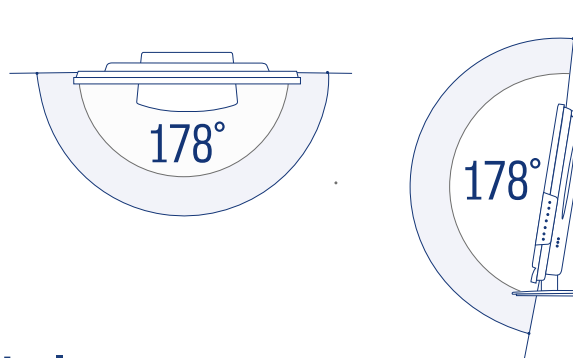

alpha **VIEW**
electronics

alphatronicsView – wide-angle LED display

The innovative alphatronicsView wide-angle LED display means that you can enjoy a great view of your TV from any position. Thanks to the 178-degree horizontal and vertical viewing angle, you always have best view. Using alphatronicsView technology, the wide-angle display is individually adapted to each TV model's main electronics system.

This is done by integrating the contrast and brightness values of the respective LED panel. For devices that are not mounted at eye level, with normal LED panels the image quality can be significantly affected if you are not able to sit within the optimum viewing angle.

To be found in all alphatronics TVs.

The digital satellite receiver is already inside.

HDTV



Now you can design
your own channel list

Go to www.alphanetronics.de/en for more information
and click on the Support/Tips and Tricks tab

alphanetronics SL-24 DSBI+

LED display

60 cm (24") screen

Triple tuner (DVB-S2 + DVB-T2 HD + DVB-C)

Integrated Bluetooth 4.2 module

DVD player

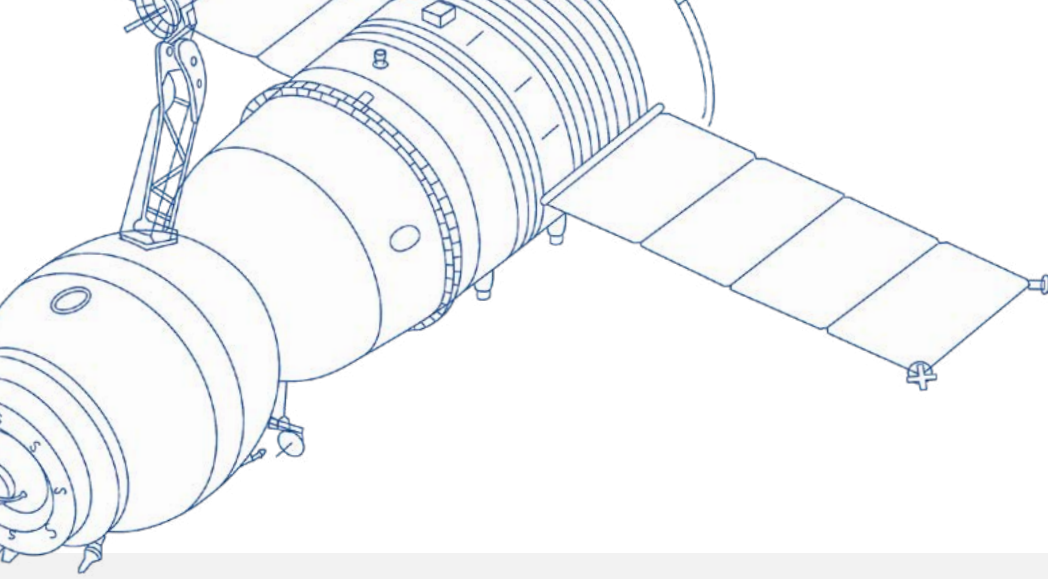

Advantages of DVB-S2:

- Significantly better image and sound quality
- Wide variety of programmes, also for HD TV
- Reception of international and regional programmes
- Attractive additional digital services such as Electronic Programme Guide (EPG)
- Reception of digital radio

Common Interface (CI+):

Thanks to the future-proof CI+ slot, you can receive pay TV programmes via DVB-S2. Simply insert the smartcard (with CA module) into the CI+ slot in the device.

Highlight of the alphatronics DVB-S2 tuner:

- Integrated display of the quality level to support the alignment of semi-automatic and manual SAT systems.
- 60 satellites pre-installed

Don't want an additional satellite receiver? Then we have the perfect TV for you.

All alphatronics TVs feature an integrated DVB-S2 tuner (MPEG-4 – HDTV). Simply connect the satellite system directly to the TV and enjoy digital TV and radio programmes. Not only do you save yourself an additional device, you also reduce the power consumption in your motorhome or caravan. In addition to the pre-programmed channel list, you can also set up your own individual channel list. Go to our website for more information (details can be downloaded). Another

important point - you only need one remote control, making the whole process easy and convenient. Store your favourite programmes in the 900 available memory slots. You can also set up your own lists of favourites and access the Electronic Programme Guide (EPG). The MPEG-4 standard enables you to receive digital TV programmes in the highest picture quality (HDTV).



DVB-S2 Tuner: Integrated into all alphatronics TVs.

DVB-T reception throughout Europe.



alphatronics T-19 SBI+

47 cm (19") screen

Triple tuner (DVB-S2 + DVB-T2 HD + DVB-C)

Integrated Bluetooth 4.2 module

**All models
with future-proof
DVB-T2 HD tuner!**

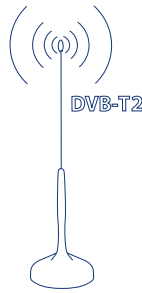

Advantages of DVB-T2 HD:

- Numerous digital programmes available in HD without cable TV subscription or satellite connection
- In Germany, you will receive all major German language and regional TV channels
- Reception via a small DVB-T antenna (alpatronics DVB-T antenna AN 1, AN 2, AN 5)
- Digital image and audio quality
- All alpatronics TVs offer HDTV reception
- You will often get reception even where satellite reception is not possible, for example in unfavourable parking spaces (under tree canopies)

Common Interface (CI+):

Thanks to the future-proof CI+ slot, you can receive pay-TV programmes via DVB-T. Simply insert the smartcard (with CA module) into the CI+ slot in the device.



Don't want to miss sporting events? alpatronics TVs offer DVB-T reception throughout Europe.

TVs with alpatronics' DVB-T tuners are equipped with a DVB-T2 receiver. This allows almost unlimited reception of digital programmes in Europe. alpatronics TVs are HD-ready (ready to receive High Definition TV – MPEG4). Simply connect an external DVB-T antenna and your TV becomes digital.

With the help of the integrated Electronic Programme Guide, the device displays the available programmes clearly. Save your favourite programmes quickly and easily to the favourites list. All TVs equipped with DVB-T2 tuners have a 5 volt active voltage, enabling the operation of active antennas.

DVB-T2 HD tuner: Integrated into all alpatronics TVs.

Receive your TV programmes via the digital cable connection.



Advantages of DVB-C:

- Significantly better image and sound quality than analogue cable reception
- Wide range of TV programmes, including HD TV
- Reception of international and regional programmes
- Attractive additional digital services such as Electronic Programme Guide (EPG)
- Digital radio reception

Common Interface (CI+):

Thanks to the future-proof CI+ slot, you can receive pay TV programmes via DVB-C. Simply insert the smartcard (with CA module) into the CI+ slot in the device.

alphatronics T-19 SBI+
47 cm (19") screen
Triple tuner (DVB-S2 + DVB-T2 HD+ DVB-C)
USB connection

Are you at a campsite with digital cable connection? Wonderful! Thanks to the alphatronics DVB-C tuner you will have reception immediately.



All models have an integrated DVB-C tuner. This allows the TV to be connected to the digital cable connection immediately. Therefore, you save yourself an additional external receiver.

Due to the MPEG-4 standard of the alphatronics triple tuner, you can also receive digital TV programmes in the highest resolution (HDTV) via the DVB-C tuner.

DVB-C tuner: Integrated into all alphatronics TVs.

The convenient way to monitor battery voltage.



Thanks to the new alphasronicsBatteryControl, you can monitor the battery charge at any time. The practical display is shown directly on your TV screen. The remaining charge of the battery currently connected to the device is displayed directly on the screen. When switching from one programme to another, it is displayed in the bottom right of the info bar.

Thanks to the battery display, it is easy to monitor the on-board battery status at any time. Problems caused by insufficient power supply to the TV,

such as loss of sound or image interference, are more easily recognised and their causes (cabling issues/cross section, low battery) can be resolved.

The alphasronicsBatteryControl is also equipped with a warning display, which indicates overcharging and low battery levels through a corresponding signal (red battery symbol).

Masterpiece of Intelligence.



Now also with
integrated
Blu-ray player!
(40" and 32")



Innovative. Modular. Unique.

The new S-Line+ is pushing the boundaries of what is technologically possible.

The **S-Line** is a unique TV concept which adapts to meet your specific requirements. The highlight is the division of the TV into two separate parts, the display screen and the control unit. Both units are separated from each other by a control cable. This offers countless benefits for use in a motorhome or caravan.

Unbeatable features.

The ultra-slim housing of the TV screen with black frame integrates harmoniously into your living environment. The S-Line is available in screen sizes 40" and 32". Simply select the appropriate TV control unit. The TV control unit is equipped as standard with a triple tuner (DVB-S2, DVB-C, DVB-T2 HD with CI+ module), Bluetooth 4.2 module, and USB and HDMI connections.

The perfect solution – the modular S-Line.

In addition to the standard features, you can choose a Blu-Ray player instead of a DVD player in the control unit. You can also choose further additional features, such as the alphantronics SMART TV functionality based on Android.

You can also choose between different cable lengths (2 m, 3 m, 4 m or 5 m) for the control cable (connection between TV display and TV control unit).

Everything that makes sense.

The S-Line+ includes all the quality characteristics that you are used to with alphantronics, whether it's the new triple tuner (DVB-S2, DVB-T2 HD, DVB-C with CI +), fast digital processor, Bluetooth 4.2 or wide-angle LED display. You don't have to compromise on anything. When it comes to sound reproduction, due to the large size of the display screens (40" and 32") we rely on the connection of speakers or separate sound bars already installed in your motorhome. For this reason, the S-Line is not equipped with integrated speakers. This has enabled us to reduce the dimensions of the TV display to the absolute minimum.

The mobile TV of the future!

We have put a lot of thought into the S-Line concept, and we have really pushed the limits of what mobile TVs can do, as well as making them more future-proof. The TV control unit can be easily replaced for a later model with new or improved features at any time. So bring on the future!

A new model of maintenance – Service 2.0

When it comes to servicing, you only need to replace the control unit: the TV display remains in the vehicle. It couldn't be easier!

The new alphantronics S-Line – a unique TV concept, developed and manufactured to suit the needs of motorhome and caravan owners.

The available models at a glance:

S-32 SB+	Triple tuner (DVB-S2, DVB-T2 HD, DVB-C), Bluetooth 4.2
S-32 DSB+	Triple tuner (DVB-S2, DVB-T2 HD, DVB-C), Bluetooth 4.2, DVD player
S-32 BSBAl+	Triple tuner (DVB-S2, DVB-T2 HD, DVB-C), Bluetooth 4.2, Blu-ray player, SMART-TV (Android)
S-40 SB+	Triple tuner (DVB-S2, DVB-T2 HD, DVB-C), Bluetooth 4.2
S-40 DSB+	Triple tuner (DVB-S2, DVB-T2 HD, DVB-C), Bluetooth 4.2, DVD player
S-40 BSBAl+	Triple tuner (DVB-S2, DVB-T2 HD, DVB-C), Bluetooth 4.2, Blu-ray player, SMART-TV (Android)

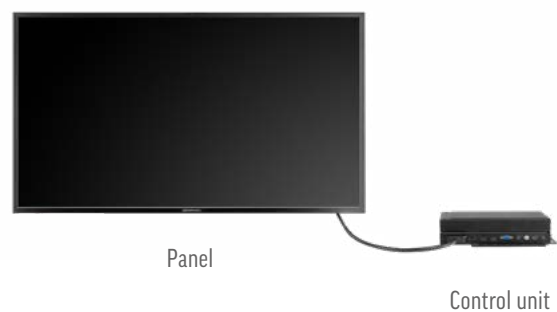

Unique sound quality, unlimited Android SMART TV functionality



alphatronics SLA-Line+ SMART TV



For the world beyond mobile TV!

The new SLA-Line+ scores all the way! Thanks to the new alphatronics SMART TV module, you have a range of Internet features at your fingertips. The Android-based system makes surfing the Internet very easy. Want to find out more about your destination, or exactly where you and your motorhome or caravan are right now? Then make the most of YouTube's variety and watch a travelogue about the local area. Or simply select any app from the app store to facilitate your caravan or motorhome journey (e.g. parking space app or petrol station finder). Use the Miracast/DLNA feature to mirror your smartphone's screen content on your TV.

The SLA-Line+ is available in screen sizes 22", 24" and 32". Equipped with the new alphatronics triple tuner (DVB-S/S2, DVB-T/T2 HD, DVB-C with CI+) for high definition television (HDTV), DVD player, USB connection, 2 x HDMI connection and integrated Bluetooth 4.2 module - features that guarantee perfect entertainment.

Thanks to the alphatronics Bluetooth 4.2 module, not only can the TV send audio signals via Bluetooth, it can also play music from a mobile phone through the TV! And it is the first mobile TV worldwide to have Bluetooth aptX low latency technology. CD sound quality, low latency for synchronised image and sound.

Thanks to the innovative alphatronicsView display, the SLA-Line+ offers LED display technology of the future. The innovative wide-angle LED display means that you can enjoy a great view of your TV from any position. All this, plus brilliant image quality with very low power consumption.



SLA-Line+	SLA-22 DSBAI+	SLA-24 DSBAI+	SL-32 DSBAI+
SMART TV (Android operating system)	•	•	•
alphatronicsSound Bluetooth 4.2 module	•	•	•
Bluetooth aptX low latency technology	•	•	•
alphatronicsView wide-angle display (178°/178°)	•	•	•
Triple tuner (DVB-S2, DVB-T2 HD, DVB-C, CI+, HDTV)	•	•	•
Integrated display of the quality level (DVB-S2)	•	•	•
Programmable channel lists	•	•	•
DVD player	•	•	•
DLNA/Miracast (screen mirroring)	•	•	•
2x USB connections	•	•	•
2x HDMI connections	•	•	•
5V output for active DVB-T antennas	•	•	•
On/off switch	•	•	•
AN 5 DVB-T antenna included in delivery	•	•	•



When sound becomes an experience!

The integrated loudspeakers in the SLA-Line project sound towards the front: ideal for the special usage conditions in motorhomes. They create an authentic, rich and full sound experience in your vehicle. Now you can transmit from your smartphone to the TV and use the powerful integrated speakers to play music.



Qualcomm® aptX™
Low Latency

The first mobile TV with Bluetooth aptX low latency technology

- Bluetooth aptX enables CD sound quality thanks to an improved compression process.
- Lower latency – ideal for audio transmission from TV to headphones.
- Perfect synchronisation of image and sound

The sound of the new SLA-Line+ now provides what the image quality always has: that home cinema feeling in your motorhome or caravan.



alphatronics HOME SCREEN

Everything that's important to you!

Thanks to the SLA-Line+ home screen, you have everything in view! The operator prompts are clearly structured and easy to use. The home screen provides access to the app store, Internet browser and list of apps, which you can tailor to your individual requirements.

You can also save your favourite apps, for example a specific media library, directly to the home screen. This means it is immediate accessible once you switch on the TV.



alphatronics app list

Wide range of pre-installed options.

A range of the best Internet apps and tools comes pre-installed! Access online video libraries directly or make the most of the Miracast/DLNA feature which enables you to mirror the screen content of your smartphone on the TV. Find the necessary app in the alphasatronics app list.

Note: Illustrations show optional examples, not standard features.



alpha LINK

alpha AUDIO+

alpha ViEW

alpha sound

Bluetooth 4.2

DVB-T2 HD

LED DISPLAY

FULL-HD Resolution

The alphasatronics SLA-Line+ SMART TV with Android operating system



SL-32 DSBAI+

- LED display
- 80 cm (32") screen
- Triple tuner (DVB-S2, DVB-T2 HD, DVB-C Tuner HDTV)
- Integrated Bluetooth 4.2 module
- USB connection
- DVD player



SLA-24 DSBAI+

- LED display
- 60 cm (24") screen
- Triple tuner (DVB-S2, DVB-T2 HD, DVB-C Tuner HDTV)
- Integrated Bluetooth 4.2 module
- USB connection
- DVD player



SLA-22 DSBAI+

- LED display
- 55 cm (22") screen
- Triple tuner (DVB-S2, DVB-T2 HD, DVB-C Tuner HDTV)
- Integrated Bluetooth 4.2 module
- USB connection
- DVD player

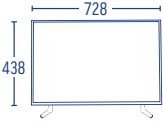
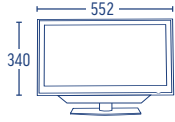
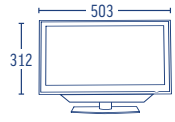
Model		SL-32 DSBAI+	SLA-24 DSBAI+	SLA-22 DSBAI+
SCREEN	Screen size	80 cm (32")	60 cm (24")	55 cm (22")
	alphatronics 178° / 178° wide-angle display	LED display	LED display	LED display
	Image format	16:9 Widescreen	16:9 Widescreen	16:9 Widescreen
	Resolution	1920 x 1080 Full-HD	1920 x 1080 Full-HD	1920 x 1080 Full-HD
	Contrast ratio	3000:1	1,000:1	1,000:1
	Brightness value	200 cd/m ²	300 cd/m ²	350 cd/m ²
	Response time	< 8 ms	< 5 ms	< 5 ms
	Viewing angle	178 H, 178 V	178 H, 178 V	178 H, 178 V
TUNER	PAL B/G, NTSC, SECAM	●	●	●
TON	Music output / Watt	2 x 5 W	2 x 5 W	2 x 5 W
	Integrated speakers at the front	● (below)	●	●
	Stereo sound	●	●	●
	alphatronicsAUDIO+	●	●	●
CONNECTIONS	TV tuner	●	●	●
	2x HDMI connections	●	●	●
	AV in / AV out	●	●	●
	Headphones (3.5 mm)	●	●	●
	YPbPR connection (3.5 mm)	●	●	●
	Digital Coaxial Out	●	●	●
	10.8 - 26 V DC supply voltage	●	●	●
	External power supply 100 - 240 V AC, 12 DC	●	●	●
Bluetooth aptX low latency technology	●	●	●	
alphatronicsSound	Integrated Bluetooth 4.2 module	●	●	●
	Pairing via OSD menu	●	●	●
TUNER	Triple tuner (DVB-S2, DVB-T2 HD, DVB-C Tuner - HDTV MPEG2/4)	●	●	●
	Integrated display of the quality level (DVB-S2)	●	●	●
	CI+ slot (Common Interface)	●	●	●
	Electronic Programme Guide (EPG)	●	●	●
	Favourites list	●	●	●
	Parental control	●	●	●
PhotoViewer	2x USB 2.0 connections / media player (PVR feature can be retrofitted)	●	●	●
DVD player	Laterally integrated DVD player	●	●	●
	Formats: CD, DVD, VCD, MP3, DVD-R, DVD-RW, DivX, JPEG	●	●	●
INTERNET	SMART TV (Android operating system)	●	●	●
FEATURES	Automatic station search storage	●	●	●
	Max. TV programme slots	999	999	999
	Videotext TOP (100 pages)	●	●	●
	Image modes - number	4	4	4
	Sound modes - number	5	5	5
	Sleep timer	●	●	●
	Graphical OSD menu (multilingual)	●	●	●
GENERAL	Power consumption	Operation < 37 W (max.) Standby < 0.5 W	Operation < 27 W (max.) Standby < 0.5 W	Operation < 26.5 W (max.) Standby < 0.5 W
	Weight	With base 7.5 kg Without base 5.7 kg	With base 4.2 kg Without base 3.9 kg	With base 3.7 kg Without base 3.4 kg
	Dimensions (W x H x D in mm)			
		With base 728 x 468 x 185	With base 552 x 390 x 175	With base 503 x 361 x 175
		Without base 728 x 428 x 55	Without base 552 x 355 x 50	Without base 503 x 326 x 50
	Housing colour	High-gloss black	Brushed anthracite	Brushed anthracite
	HD-ready/Full HD	● / Full HD	● / Full HD	● / Full HD
	VESA Standard (100 x 100 mm)	● 100 x 200 mm	●	●
	Energy efficiency class	A	A	A
	On/off switch	●	●	●
Accessories	Remote control, AN5 DVB-T antenna, mains adapter, YbPR adapter, AV adapter, automotive 12 volt cables, batteries, operating instructions	●	●	●



 **Included in delivery:
AN 5 DVB-T Antenna**

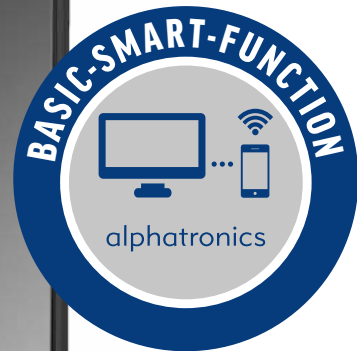

Info Recording function thanks to free software upgrade for all our TVs!

alphatronics SL-Line+ Individual



The SL-Line+ with Basic Smart feature.

You will be impressed by the added technological features offered by the SL-Line+. The Basic Smart feature enables easy Internet surfing thanks to the integrated browser. Furthermore, a wide selection of apps is available. And now you can display the screen content of your mobile phone in large-scale format. Thanks to the Miracast/DLNA feature, you can mirror your smartphone's screen content to the TV (the TV and smartphone must first be registered on the same network).

As with all alphatronics TVs, all models in the SL-Line+ are also equipped with Bluetooth 4.2. The new Bluetooth 4.2 as standard provides even faster connection, a wider range and lower consumption. The colour resolution offers an even greater range of radiant colours. The new AUDIO DSP technology provides a better sound experience and a new digital processor for faster access to your favourite stations.

The SL-Line+ is available in the screen sizes 19", 22", 24" and 32". Equipped with the new alphatronics triple tuner (DVB-S/S2, DVB-T/T2 HD, DVB-C with CI+) for high-definition television (HDTV), DVD player, USB connection (DSBI+ models: 2x USB), 2 x HDMI connections and integrated Bluetooth module – features that guarantee perfect entertainment.

Thanks to the innovative alphatronicsView display, the SL-Line+ offers LED display technology of the future. The innovative wide-angle LED display means that you can enjoy a great view of your TV from any position. All this, plus brilliant image quality with very low power consumption.

DVB-S2, DVB-T2 HD and DVB-C tuner in one device

All models in the SL-Line+ are equipped as standard with the new alphatronics triple tuner. This consists of a DVB-S2 tuner, DVB-T2 HD tuner and DVB-C tuner. Thanks to the DVB-S2 tuner, you can connect your satellite system directly to the TV and thus receive digital TV and radio programmes without an additional receiver.

The integrated DVB-T2 HD tuner allows you to receive TV programmes via a small external DVB-T antenna in many regions of Germany and also in other European countries. You can enjoy high-definition television (HDTV) due to the MPEG4 standard of the alphatronics triple tuner (MPEG4 is the European HDTV standard). Thanks to the integrated CI+ slot (Common Interface), if you have an activated smartcard you can receive encrypted digital programmes (pay TV) via the triple tuner.

With the DVB-C tuner you can receive digital programmes over the cable network. A helpful way to use your SL-Line+ also in your home area.

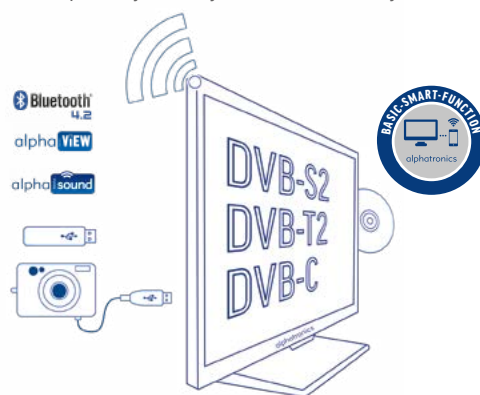

SL-Line+	SL-19 DSBI+	SL-22 DSBI+	SL-24 DSBI+	SL-32 DSBI+
Basic Smart feature (Linux operating system)	•	•	•	•
alphatronicsSound Bluetooth 4.2 module	•	•	•	•
alphatronicsView wide-angle display (178°/178°)	•	•	•	•
Triple tuner (DVB-S2, DVB-T2 HD, DVB-C, CI+, HDTV)	•	•	•	•
Integrated display of the quality level (DVB-S2)	•	•	•	•
Programmable channel lists	•	•	•	•
DVD player	•	•	•	•
DLNA/Miracast (screen mirroring)	•	•	•	•
2x USB connections	•	•	•	•
2x HDMI connections	•	•	•	•
5V output for active DVB-T antennas	•	•	•	•
On/off switch	•	•	•	•
AN 5 DVB-T antenna included in delivery	•	•	•	•

alphatronics Second Screen

Keep it simple: smart networking, intelligently done.

alphatronics SL-Line+ with Basic Smart feature (DSBI+)

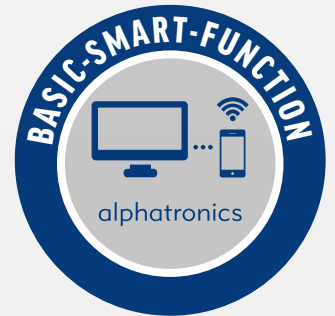

Thanks to the new DSBI+ model variant, mobile TV is even more fun.

The Basic Smart feature enables easy Internet surfing thanks to the integrated browser. Furthermore, a wide selection of apps is available. And now you can display the screen content of your mobile phone in large-scale format. With the help of the Miracast and DLNA function, data are transferred from the smartphone to the TV or the screen content of the smartphone/tablet is transferred to the TV.

**The new Basic Smart feature can be found in models:
SL-19 DSBI+, SL-22 DSBI+, SL-24 DSBI+, SL-32 DSBI+**



Wireless listening pleasure to meet the highest standards.

With the integrated Bluetooth 4.2 module!

One highlight of the new SL-Line+ is the integration of the alpatronicsSound Bluetooth 4.2 module. It enables the wireless connection of speaker systems from the alpatronicsSound range. Connect headphones or an external speaker wirelessly via Bluetooth. Save yourself laying additional annoying cables without compromising on your sound experience.

New alpatronics Bluetooth 4.2 – for even faster connection, a wider range (up to 100m) and reduced consumption (low energy).

Thanks to the alpatronics Bluetooth 4.2 module, not only can the TV send audio signals via Bluetooth, it can also play music from a mobile phone through the TV!

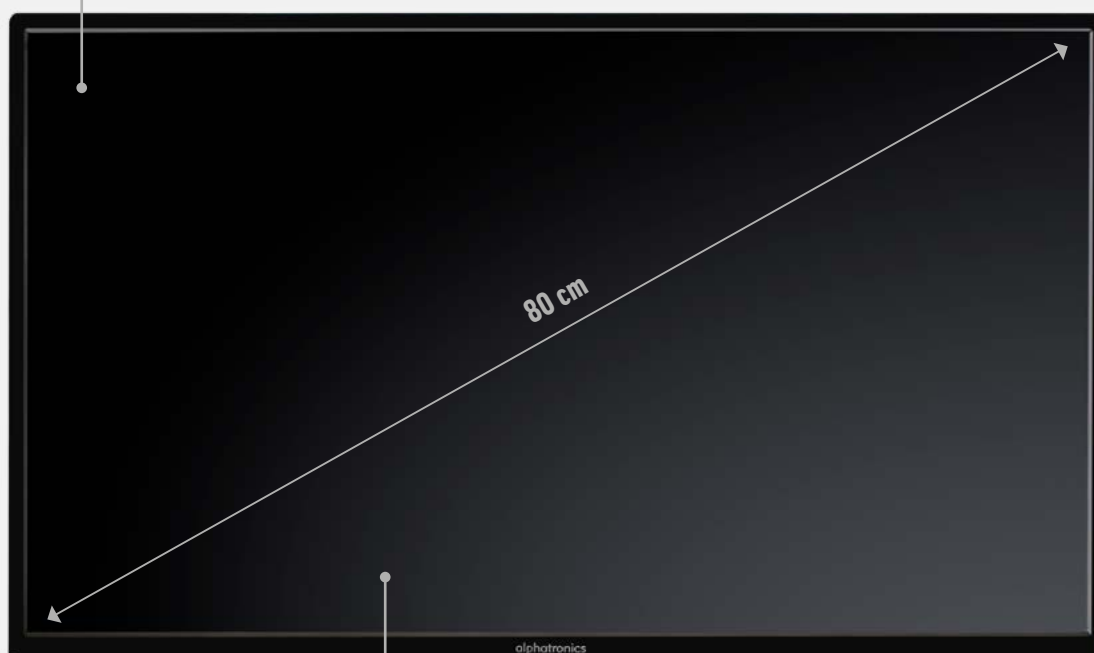

SL-32 DSBI+

80 cm screen diagonal – the SL-32 DSBI+ is the largest mobile TV, with the same features as the SL-19 DSBI+, SL-22 DSBI+ or SL-24 DSBI+ models.

From now, you can control the satellite system via your TV.



Together with Kathrein, alphasatronics has developed the innovative “one-cable solution”. The -K model enables you to control various fully automated Kathrein satellite systems directly via your TV without even needing an additional remote control or receiver.

You actually only need two components for TV and radio reception - a -K variant model from the SL-Line+ and a satellite system from Kathrein. Both the rotating unit and the satellite signal to the TV are controlled through the same coaxial cable.

A further highlight is the option to stream TV programmes to a smartphone or tablet.



SL-Line	SL-19 DSB+ K	SL-22 DSB+ K	SL-24 DSB+ K
One-cable solution	•	•	•
alphatronicsSound Bluetooth 4.2 module	•	•	•
alphatronicsView wide-angle display (178°/178°)	•	•	•
Triple tuner (DVB-S2, DVB-T2, DVB-C, CI+, HDTV)	•	•	•
Integrated display of the quality level (DVB-S2)	•	•	•
Programmable channel lists	•	•	•
DVD player	•	•	•
USB connection	•	•	•
2x HDMI connections	•	•	•
5V output for active DVB-T antennas	•	•	•
On/off switch	•	•	•
AN 5 DVB-T antenna included in delivery	•	•	•

KATHREIN - New for 2020

Software updates via satellite – Stay ready to receive wherever you are, thanks to automatic overnight updating.



Convincing advantages:

- Developed and manufactured in Germany
- Protected cable routing on the rotating antenna
- Option to connect a second receiver or TV
- Stream live TV with UFZ 131 WiFi/USB adapter and free CAPcontrol app
- Automatic updates
- CI-BUS compatible thanks to available adapter
- Aerodynamic design

Rotating antennas



CAP 650 GPS

- Compact, fully automatic satellite antenna
- Requires very little space



CAP 850 GPS

- Only 17 cm high
- Large reception area thanks to 85 cm parabolic reflector with high gains



CAP 750 GPS

- Weight < 10 kg – one of the lightest fully automatic satellite antennas
- Optimal aerodynamics (low air resistance and noise emission)



One-cable solution – Kathrein and alphatronics

- Only one cable between TV and rotating unit (coaxial cable)
- Can be conveniently positioned directly via the TV menu
- Lower electricity consumption
- Very easy to install
- No additional external controller
- Optimised weight
- Space-saving
- Feedback from the SAT system is displayed on the screen in plain text



The alphasatronics SL-Line+ Individual

Rediscover mobile TV



SL-32 DSBI+

LED display
80 cm (32") screen
Triple tuner (DVB-S2, DVB-T2 HD, DVB-C tuner HDTV)
Integrated Bluetooth 4.2 module
USB connection

SL-24 DSBI+

LED display
60 cm (24") screen
Triple tuner (DVB-S2, DVB-T2 HD, DVB-C tuner HDTV)
Integrated Bluetooth 4.2 module
USB connection

SL-22 DSBI+

LED display
55 cm (22") screen
Triple tuner (DVB-S2, DVB-T2 HD, DVB-C Tuner HDTV)
Integrated Bluetooth 4.2 module
USB connection

SL-19 DSBI+

LED display
47 cm (19") screen
Triple tuner (DVB-S2, DVB-T2 HD, DVB-C tuner HDTV)
Integrated Bluetooth 4.2 module
USB connection

Overview of all available models and variants:

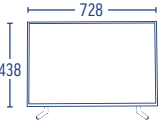
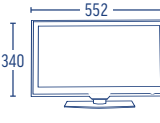
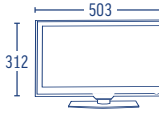
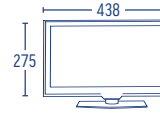

	DSBI+	-K
SL-19	•	•
SL-22	•	•
SL-24	•	•
SL-32	•	-

Model		SL-32 DSBI+	SL-24 DSBI+	SL-22 DSBI+	SL-19 DSBI+	
SCREEN	Screen size	80 cm (32")	60 cm (24")	55 cm (22")	47 cm (19")	
	alphatronics 178°/ 178° wide-angle display	LED display	LED display	LED display	LED display	
	Image format	16:9 Widescreen	16:9 Widescreen	16:9 Widescreen	16:9 Widescreen	
	Resolution	1920 x 1080 Full-HD	1920 x 1080 Full-HD	1920 x 1080 Full-HD	1366 x 768	
	Contrast ratio	3000:1	1,000:1	1,000:1	3000:1	
	Brightness value	200 cd/m ²	300 cd/m ²	350 cd/m ²	300 cd/m ²	
	Response time	< 8 ms	< 5 ms	< 5 ms	< 5 ms	
	Viewing angle	178 H, 178 V	178 H, 178 V	178 H, 178 V	178 H, 178 V	
TUNER	PAL B/G, NTSC, SECAM	●	●	●	●	
TON	Music output / Watt	2 x 5 W	2 x 5 W	2 x 5 W	2 x 5 W	
	Integrated speakers	●	●	●	●	
	Stereo sound	●	●	●	●	
	alphatronicsAUDIO+	●	●	●	●	
CONNECTIONS	TV tuner	●	●	●	●	
	2x HDMI connections	●	●	●	●	
	AV in / AV out	●	●	●	●	
	Headphones (3.5 mm)	●	●	●	●	
	YPbPR connection (3.5 mm)	●	●	●	●	
	Digital Coaxial Out	●	●	●	●	
	10.8 - 26 V DC supply voltage	●	●	●	●	
	External power supply 100 - 240 V AC, 12 DC	●	●	●	●	
	alphatronicsSound	Integrated Bluetooth 4.2 module	●	●	●	●
	Pairing via OSD menu	●	●	●	●	
TUNER	Triple tuner (DVB-S2, DVB-T2 HD, DVB-C Tuner - HDTV MPEG2/4)	●	●	●	●	
	Integrated display of the quality level (DVB-S2)	●	●	●	●	
	CI+ slot (Common Interface)	●	●	●	●	
	Electronic Programme Guide (EPG)	●	●	●	●	
	Favourites list	●	●	●	●	
	Parental control	●	●	●	●	
PhotoViewer	USB 2.0 connection / Media player (PVR feature can be retrofitted)	●	●	●	●	
	2x USB 2.0 connections / media player (PVR feature can be retrofitted)	●	●	●	●	
DVD player	Laterally integrated DVD player	●	●	●	●	
	Formats: CD, DVD, VCD, MP3, DVD-R, DVD-RW, DivX, JPEG	●	●	●	●	
Internet	alphatronics Basic Smart feature (DSBI+)	●	●	●	●	
Kathrein control	-	-	● -K	● -K	● -K	
FEATURES	Automatic station search storage	●	●	●	●	
	Max. TV programme slots	999	999	999	999	
	Videotext TOP (100 pages)	●	●	●	●	
	Image modes - number	4	4	4	4	
	Sound modes - number	5	5	5	5	
	Sleep timer	●	●	●	●	
	Graphical OSD menu (multilingual)	●	●	●	●	
GENERAL	Power consumption	Operation < 36 W (max.) Standby < 0.5 W	Operation < 23 W (max.) Standby < 0.5 W	Operation < 24 W (max.) Standby < 0.5 W	Operation < 19 W (max.) Standby < 0.5 W	
	Weight	With base 7.5 kg Without base 5.7 kg	With base 4.2 kg Without base 3.9 kg	With base 3.7 kg Without base 3.4 kg	With base 2.9 kg Without base 2.6 kg	
	Dimensions (W x H x D in mm)					
		With base	728 x 468 x 185	552 x 373 x 175	503 x 345 x 175	438 x 308 x 175
		Without base	728 x 428 x 55	552 x 340 x 52	503 x 312 x 52	438 x 275 x 50
		Housing colour	High-gloss black	Brushed anthracite	Brushed anthracite	Brushed anthracite
	HD Ready / Full HD	● / Full HD	● / Full HD	● / Full HD	●	
	VESA Standard (100 x 100 mm)	● 100 x 200 mm	●	●	●	
	Energy efficiency class	A	A	A	A	
	On/off switch	●	●	●	●	
	Accessories	Remote control, AN 5 DVB-T antenna, mains adapter, YPbPR adapter, AV adapter, automotive 12 volt cables, batteries, operating instructions	●	●	●	●

You can't fault it.

State-of-the-art technology and elegant design.



alphatronics T-Line+

The new Slimline with Basic Smart feature.



A highlight of the new T-Line+ is the new Basic Smart feature. This enables easy Internet surfing thanks to the integrated browser. Furthermore, a wide selection of apps is available. And now you can display the screen content of your mobile phone in large-scale format. With the help of the Miracast and DLNA function, the screen content is mirrored from the smartphone to the TV (the TV and smartphone must be registered in the same network to do so).

The colour resolution is also new, for an even greater range of radiant colours. The new AUDIO DSP technology provides a better sound experience and a new digital processor for faster access to your favourite stations.

Thanks to the high-quality surface in brushed silver, the T-Line+ integrates harmoniously into your living environment.

The ultra-thin frame has enabled the extremely small dimensions of both screen sizes. If you have limited space, you can now opt for a slightly larger screen (22" instead of the previous 19" screen size). The LED display allows you to experience mobile TV with rich colours and enormous depth of field, and all with extremely low power consumption.

Another highlight is the integrated alphatronicsSound Bluetooth 4.2 module. Easily connect the wireless speakers from the alphatronicsSound product line directly to the TV. Transmit sound wirelessly to Bluetooth-enabled navigation devices or radios and make use of your vehicle's pre-installed speakers. Thanks to the Bluetooth 4.2 module, you can also transmit music from your smartphone.

DVB-S2, DVB-T2 HD and DVB-C tuner in one device

Both T-Line+ models come with the alphatronics triple tuner as standard. This consists of a DVB-S2 tuner, DVB-T2 HD tuner and DVB-C tuner.



T-Line+	T-22 SBI+	T-19 SBI+
Basic Smart feature (Linux operating system)	•	•
alphatronicsSound Bluetooth 4.2 module	•	•
alphatronicsView wide-angle display (178°/178°)	LED	LED
Triple tuner (DVB-S2, DVB-T2 HD, DVB-C, CI+, HDTV)	•	•
Integrated display of the quality level (DVB-S2)	•	•
Programmable channel lists	•	•
alphatronicsSound Bluetooth 4.2 module	•	•
USB connection	•	•
2x HDMI connections	•	•
5V output for active DVB-T antennas	•	•
HD-ready	• / Full HD	•
On/off switch	•	•
AN 5 DVB-T antenna included in delivery	•	•

The alphasatronics T-Line+

Perfection in a slimline design.

**LED
DISPLAY**

**FULL-HD
Resolution**



T-22 SBI+

Thanks to the screen diagonal of 55 cm in 16:9 widescreen format, watching TV becomes an experience. The full-HD LED display offers an impressive viewing image with higher resolution and better colour rendering.

LED display

55 cm (22") screen

Triple tuner (DVB-S2, DVB-T2 HD, DVB-C tuner HDTV)

Integrated Bluetooth 4.2 module

USB connection



T-19 SBI+

Both T-Line models offer TV with entertainment qualities. A triple tuner (DVB-S2, DVB-T2 HD, DVB-C) for the reception of HDTV is integrated as standard.

LED display

47 cm (19") screen

Triple tuner (DVB-S2, DVB-T2 HD, DVB-C tuner HDTV)

Integrated Bluetooth 4.2 module



USB connection

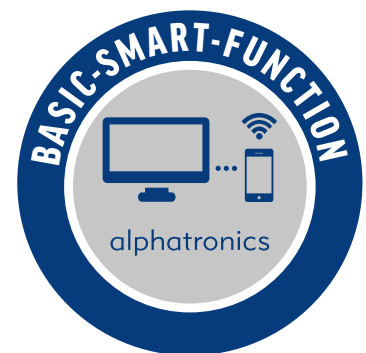

All models with on/off switch.

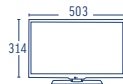

Did you know? The alphasatronicsSound Bluetooth feature enables you to listen through headphones and the TV at the same time. This means that even when you have headphones connected, others can still hear the sound through the TV!

Model		T-22 SBI+	T-19 SBI+	
SCREEN	Screen size	55 cm (22")	47 cm (19")	
	alphatronicsView wide-angle display (178°/178°)	LED display	LED display	
	Image format	16:9 Widescreen	16:9 Widescreen	
	Resolution	1920 x 1080 Full-HD	1366 x 768	
	Contrast ratio	1,000:1	3000:1	
	Brightness value	300 cd/m ²	300 cd/m ²	
	Response time	< 5 ms	< 5 ms	
	Viewing angle	178 H, 178 V	178 H, 178 V	
TUNER	PAL B/G, NTSC, SECAM	●	●	
TON	Music output / Watt	2 x 5 W	2 x 5 W	
	Integrated speakers	●	●	
	Stereo sound	●	●	
CONNECTIONS	TV tuner	●	●	
	2x HDMI connections	●	●	
	Headphones (3.5 mm)	●	●	
	AV in / AV out	●	●	
	YPbPR connection (3.5 mm)	●	●	
	Digital Coaxial Out	●	●	
	10.8 - 26 V DC supply voltage	●	●	
	External power supply 100 - 240 V AC, 12 DC	●	●	
alphatronics-Sound	Integrated Bluetooth 4.2 module	●	●	
	Pairing via OSD menu	●	●	
TUNER	Triple tuner (DVB-S2, DVB-T2 HD, DVB-C tuner - HDTV MPEG2/4)	●	●	
	Integrated display of the quality level (DVB-S2)	●	●	
	CI+ slot (Common Interface)	●	●	
	Electronic Programme Guide (EPG)	●	●	
	Favourites list	●	●	
	Parental control	●	●	
PhotoViewer	USB 2.0 connection / Media player (PVR feature can be retrofitted)	●	●	
Internet	Basic Smart feature	●	●	
FEATURES	Automatic station search storage	●	●	
	Max. TV programme slots	999	999	
	Videotext TOP (100 pages)	●	●	
	Image modes - number	4	4	
	Sound modes - number	5	5	
	Sleep timer	●	●	
	Graphical OSD menu (multilingual)	●	●	
GENERAL	Power consumption	Operation < 20 W (max.) Standby < 0.5 W	Operation < 18 W (max.) Standby < 0.5 W	
	Weight	With base 3.3 kg Without base 3.0 kg	With base 2.7 kg Without base 2.4 kg	
	Dimensions (W x H x D in mm)	 With base: 503 x 342 x 153 Without base: 503 x 312 x 43	 With base: 438 x 310 x 153 Without base: 438 x 275 x 43	
	Housing colour	Brushed silver	Brushed silver	
	HD-ready	● / Full HD	●	
	VESA Standard (100 x 100 mm)	●	●	
	Energy efficiency class	A	A	
	On/off switch	●	●	
	Accessories	Remote control, AN5 DVB-T antenna, mains adapter, YPbPR adapter, AV adapter, batteries, operating instructions	●	●

alphatronicsSound – Bluetooth sound system

Innovation has never sounded so good.

Convincing advantages!

- Impressive sound experience
- Quick and easy to install
- No cable laying, easy to set up
- Bluetooth range approx. 10m
- Any Bluetooth-enabled receiver can be connected
- **Simply connect a set of Bluetooth headphones to your TV (with the option to listen via headphones and TV speakers simultaneously). The volume of the TV and the headphones can be controlled separately.**



From now on, you can look forward to an outstanding sound experience in your motorhome or caravan! And the best part is that the music is literally in the air.

The alphatronicsSound system provides wireless transmission of audio signals from, for example, your TV to an alphatronicsSound speaker or set of alphatronicsSound headphones. The system has been developed on the basis of the Bluetooth radio transmission especially for the needs of motorhome and caravan owners.

It is simple and convenient to use: at the touch of a button, the alphatronicsSound loudspeaker is set in ready-to-receive mode. Now it can quickly be connected to Bluetooth-enabled devices.

From now on, laboriously installing cables in motorhomes or caravans is a thing of the past. Thanks to the Bluetooth 4.2 connection, you can connect the TV and speakers wirelessly over a distance of up to 100 metres.

Bluetooth module already integrated!

All alphatronics TVs are equipped with an integrated Bluetooth module. This enables you to connect your alphatronicsSound system directly and comfortably to each alphatronics TV. You can then use the TV menu to control the features of the relevant speaker. All TVs have an integrated Bluetooth 4.2 module. This allows the TV to send and receive audio signals via Bluetooth.

For TVs without an integrated Bluetooth module, we offer the convenient BA 2 Bluetooth upgrade module. This upgrade module makes any TV Bluetooth-compatible (connection via 3.5mm jack).



alphatronicsSound 1.4.0

Bluetooth 4.0 soundbar



Included in delivery:
APH 1 mounting bracket

Experience a captivating sound through the alphatronicsSound 1.4.0 – Bluetooth 4.0 soundbar. The high-end soundbar is just 48 cm wide, and has been specifically optimised for the special conditions in motorhomes and caravans. The coordinated full-range stereo system enables an optimal bass volume despite the extremely flat design.

The use of high-quality loudspeaker membranes with an output power of 2x 20 watts (RMS) guarantees superior listening pleasure. Cabled connection is also an option if required.

Features: Bluetooth 4.0 stereo soundbar, 2x 20 W RMS with passive bass, auto on/off, USB connection (MP3 playback function) with charging function for smartphone, TF card reader, audio line in connection, coax audio input, frequency response 50 Hz – 18 kHz, DC 10 – 15 V/2 A

Dimensions: 480 x 60 x 60 mm (W x H x D in mm)

Included in delivery: Soundbar, APH 1 mounting bracket, remote control, operating instructions

alphatronics T1 keyboard

The alphatronics plug & play keyboard has a large touchpad for ease of use with your SMART TV.

Technical details:

Wireless touchpad keyboard

2.4 GHz technology

10 metre wireless range

Ergonomic key positioning with multimedia keys

Plug & play set-up, USB interface for connection



Supported operating systems:

Windows 2000/XP/Vista/Win 7/8/10, Android operating system, alphatronics SMART TVs – SLA-Line+

Included in delivery:

Keyboard, USB 2.0 interface, 2x AAA batteries

BA 2

Bluetooth upgrade module

Simultaneously connect 2 devices!

The BA 2 upgrade module simultaneously connects two sets of headphones, or headphones and speakers. Headphones or speakers are connected to the TV via the 3.5mm jack and USB port (power supply).

Features: Bluetooth upgrade module for devices without Bluetooth feature, 2 devices at the same time, power supply via USB port, weight 14g.

Dimensions: 45 x 32 x 8 mm (W x H x D in mm)



Perfect reception, wherever you are.



AN 1 DVB-T antenna

Active DVB-T mini antenna for indoor and outdoor installation, integrated low noise amplifier, HDTV compatible. Low power consumption, as the supply is via the TV's antenna socket.

Cable length: 3 m

Weight: 0.1 kg

Dimensions: W 14.5 cm x H 1.6 cm x D 3.0 cm



AN 2 DVB-T antenna

Active omnidirectional (360°) DVB-T antenna for outstanding reception. Suitable for indoor and outdoor installation (weather resistant). Integrated low noise amplifier, HDTV compatible. 5 volt power supply via the TV.

Antenna diameter: 26 cm, height 12 cm,

weight: 0.6 kg

Included in delivery: Mounting bracket, mains adapter, screws



AN 5 DVB-T rod antenna

Active DVB-T/T2 antenna for indoor installation. The magnetic base enables easy attachment to metal surfaces. No antenna alignment required. Power (5 volts) is supplied directly via the DVB-T receiver/TV or via 12 volt DC. Connecting cable included in delivery.

Dimensions: 162 x 70mm

Weight: 0.1 kg

Included in delivery: Antenna, 3 m cable, operating instructions



Technical data	AN 1	AN 2	AN 5
UHF amplification:	18 dB	24 dB	24 dB
Diameter		25.5 cm	7 cm
Height	1.6 cm	12 cm	16 cm
Weight	0.1 kg	0.6 Kg	0.1 kg
Power supply	5 V from TV	5 V from TV/12 V/24 V/230 V	5 V from TV

PROBUM DVB-T PRO antenna

PROBUM DVB-T PRO

Patented windscreen or “film” antenna

For some years now, windscreen or film antennas have been making their way into the automotive industry. Film technology offers the option of adapting complex shapes with long-term stability, in particularly very slim, narrow shapes. Antretter & Huber’s unique antenna performance offers you a concept that has been tried and tested millions of times.

High-Tech “Made in Bavaria”

The company manufactures high-performance antennas in its own production facility in Bavaria. In addition, each individual antenna goes through a strict function and quality control before delivery.



Stable antennas and excellent reception thanks to patented technology with high-quality filter components.

Patented STATE-OF-THE-ART TECHNOLOGY for your motorhome or caravan

- Automotive-certified components (AEC-Q)
- Automotive-certified antenna film
- Electrical enclosure to IP54 standard
- UV stability of film guaranteed for 7 years
- Legal security in accordance with RED 2014/53/EU
- + 20dBi antenna gain
- Film technology patented in the automotive industry
- Integrated filters to suppress interference signals
- Low Noise Amplifier (LNA) for best signal quality and longest range
- Components tested for durability
- Easy to install
- Patented antenna shape

The DVB-T2 HD antenna is easy to install. You don’t need any tools, nor do you have to drill holes in the roof of your motorhome/caravan. The thin, flexible, lightweight antenna adapts to any curvature and disappears invisibly behind the panelling or trunk of your motorhome/caravan.

The benefits for motorhome owners:

- Easy installation with 3M adhesive film
- No need to drill holes into your motorhome or caravan
- Can be concealed behind furniture
- Flexible film adapts to any curvature



Technical data	PROBUM DVB-T PRO antenna
Weight	63 g
System impedance	75 ohm
Typical current	50 mA
Polarisation	vertical/horizontal
max. gain	20 dBi
VSWR	< 1.8
Nominal voltage	5 V
Frequency	470 MHz – 780 MHz
Dimensions	260 mm x 210 mm x 5.5 mm
Included in delivery	2.5 m antenna cable, TV antenna

alpatronics

Premium Service

It has always been our aim to offer you the best service as well as the best quality. Our new alpatronics Premium Service now offers further useful services related to our mobile TVs.



alpatronics

Warranty extension

Add a cost-effective extension to the existing manufacturer's warranty for your high-quality alpatronics TV. In the event that you need a repair, we offer you the quality of service you are used to from alpatronics. Our in-house service technicians will repair your TV quickly, easily and without any additional cost to you.

One-time warranty extension from the existing 3 years to 4 years €49 (incl. VAT).

To get the warranty extension, simply visit the www.alpatronics.de website and go to the Support/ Warranty Extension section to take advantage of this offer immediately online.



Scan the QR code and extend your warranty:



www.alphatronics.de
www.alphatronics.de/en

alphatronics

alphatronics GmbH
Breitengraserstraße 6
90482 Nuremberg

Tel. +49 (0) 911 21 65 54-0
Fax +49 (0) 911 21 65 54-65
Email: info@alphatronics.de
Web: www.alphatronics.de

Social Media:

 www.facebook.com/alphatronicsgmbh
 www.instagram.com/alphatronics.gmbh

You can only find alphatronics products
at qualified camping/caravan dealers.

This alphatronics catalogue was given to you by:



Experience the world of alphatronics online.
Simply capture this QR code with your smartphone.

